



NUMBER: 23-016-10

GROUP: Body

DATE: September 22, 2010

This bulletin is supplied as technical information only and is not an authorization for repair. No part of this publication may be reproduced, stored in a retrieval system, or transmitted, in any form or by any means, electronic, mechanical, photocopying, or otherwise, without written permission of Chrysler Group LLC.

SUBJECT:

Water Leaks At The Front And/Or Rear Roof Area

OVERVIEW:

This bulletin involves inspecting the front and/or rear of the headliner for dampness. If necessary add additional seam sealer to the roof ditch and replacing the front and/or rear sunroof drain tubes.

MODELS:

2007 - 2010 (MK74) Patriot

NOTE: This bulletin applies to vehicles built before August 20,2010 (MDH0820XX).

SYMPTOM/CONDITION:

Water leaks from the roof ditch and sunroof area.

DIAGNOSIS:

The customer may experience dampness at the front and/or rear of the headliner.

PARTS REQUIRED:

| Qty. | Part No. | Description |
|-------|------------|---|
| 1(AR) | 5160008AD | Tube, Right Front Sunroof Drain |
| 1(AR) | 5115794AE | Tube, Left Front Sunroof Drain |
| 2(AR) | 05160134AC | Tube, Rear Sunroof Drain |
| 2(AR) | 05027191AA | Grommet, Front Sunroof Drain Tube |
| 2(AR) | 05116250AD | Molding, Roof Ditch |
| 1(AR) | NP | Kent Hi-Tech Clear Seam Sealer P10200 or Equivalent |
| 1(AR) | NP | 3M 08984 General Purpose Adhesive Cleaner or Equivalent |



Stick with the Specialists™

INSPECTION PROCEDURE:

1. Inspect the headliner at the front and rear of the vehicle. Was there any dampness and/or water stains on the headliner?
 - a. Yes>>> Proceed to [Step #2](#).
 - b. No>>> This bulletin does not apply continue further diagnosis.
2. Lower the headliner. Perform a water flow test to the entire roof. Where there any signs of water leaking?
 - a. Yes>>> Proceed to [Step #3](#).
 - b. No>>> This bulletin does not apply continue further diagnosis.
3. If the water was leaking from the front and/or rear of the roof area and built before 12/10/2009 and is equipped with convoluted drain tubes ([Fig. 1](#)) proceed to [Step #1](#) of the repair procedure. If the vehicle was built after 12/10/2009 proceed to [Step #1](#) of roof seams and rear body plugs.

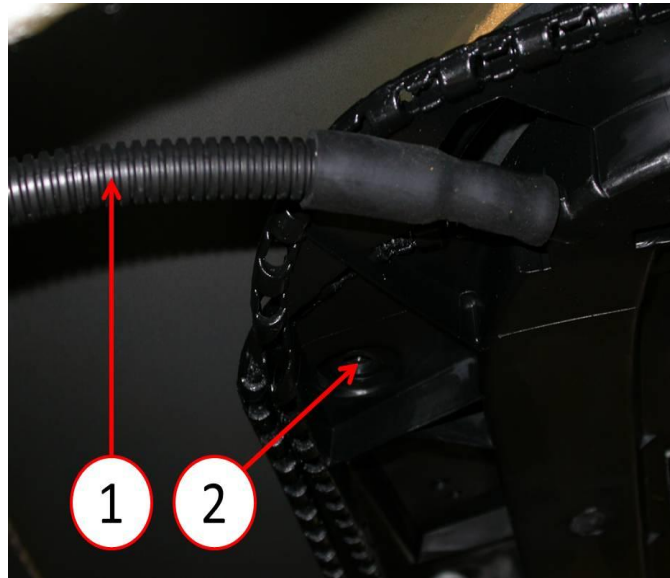

Fig. 1 Convoluted Drain Tube

1 - Convoluted Drain Tube

2 - Sunroof Module

REPAIR PROCEDURE:

1. Remove the right and left front sunroof drain tubes. Refer to the detailed removal procedures available in DealerConnect> TechCONNECT under: Service info> Body> Sunroof> Tube, Sunroof Drain> Removal.
2. Is the vehicle equipped with a manual transmission or automatic transmission?
 - a. If the vehicle is equipped with a automatic transmission proceed to [Step #1](#) of install left front drain tube for vehicles equipped with an automatic transmission only.
 - b. If the vehicle is equipped with a manual transmission proceed to install left front drain tube for vehicles equipped with an manual transmission only.

**INSTALL LEFT FRONT DRAIN TUBE FOR VEHICLES EQUIPPED WITH A
AUTOMATIC TRANSMISSION ONLY:**

1. Remove the air cleaner body. Refer to the detailed removal procedures available in DealerConnect> TechCONNECT under: Service info> Engine> Air Intake System> Body, Air Cleaner> Removal.
2. Remove the two nuts retaining the master cylinder to the brake booster and move it forward so the left front sunroof drain tube routing path can be accessed behind the left front strut tower (Fig. 2).

NOTE: Do not disconnect any brake lines connected to the master cylinder.

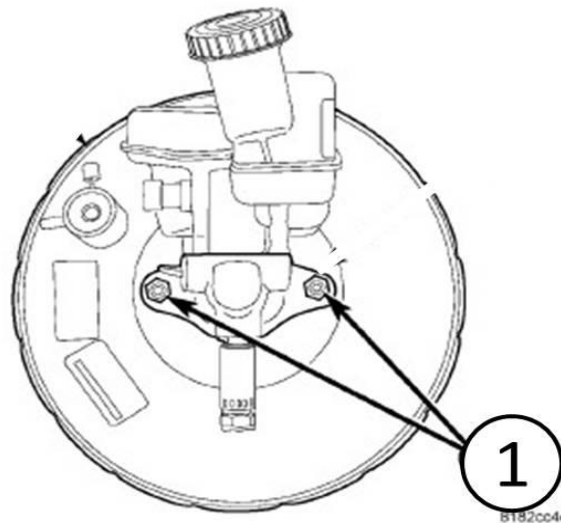

Fig. 2 Brake Booster

1 - Nuts

-
3. Remove the lower left side cowl trim panel. Refer to the detailed removal procedures available in DealerConnect> TechCONNECT under: Service info> Body> Interior> Panel, Cowl Trim, Side> Removal.
 4. Remove the kneeblocker. Refer to the detailed removal procedures available in DealerConnect> TechCONNECT under: Service info> Body> Instrument Panel> Kneeblocker> Removal.

5. Route the new left front sunroof drain tube through the engine side of the bulkhead (Fig. 3)

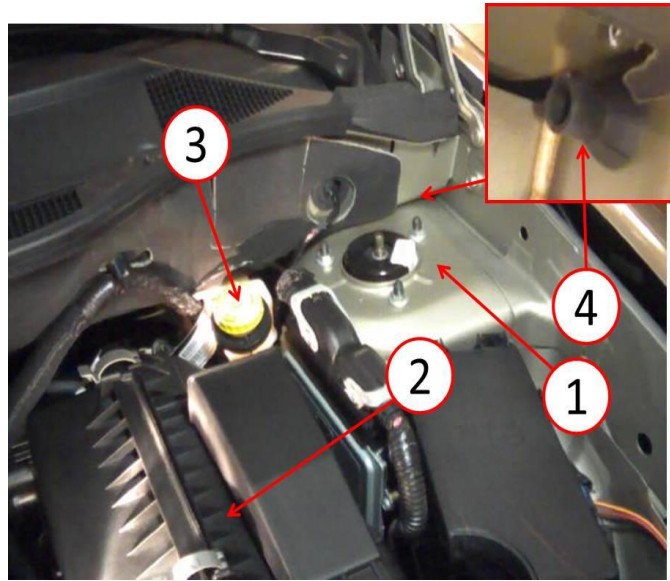

Fig. 3 Left Front Drain Tube

- 1 - Strut Tower
- 2 - Air Box
- 3 - Master Cylinder
- 4- Drain Tube Grommet

NOTE: From underneath the left side instrument panel roll back the jute between the bulk head and the instrument panel at the top left to verify drain tube routing.

6. Verify the grommet is correctly seated in the bulk head using a mirror and position it behind the strut tower looking at the upper right corner (Fig. 4).

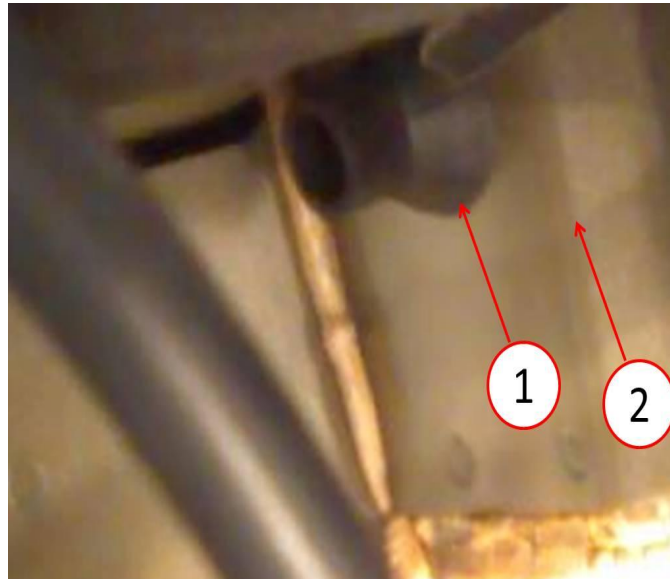

Fig. 4 Drain Tube Grommet Seated

- 1 - Drain Tube
- 2 - Bulk Head

-
7. Connect the drain tube to the sunroof drain spout.
 8. Install the Kneeblocker. Refer to the detailed removal procedures available in DealerConnect> TechCONNECT under: Service info> Body> Instrument Panel> Kneeblocker> Installation.
 9. Install the lower left side cowl trim panel. Refer to the detailed installation procedures available in DealerConnect> TechCONNECT under: Service info> Body> Interior> Panel, Cowl Trim, Side> Installation.
 10. Re-secure the master cylinder to the brake booster with the two nuts previously removed.
 11. Install the air cleaner body. Refer to the detailed Installation procedures available in DealerConnect> TechCONNECT under: Service info> Engine> Air Intake System> Body, Air Cleaner> Installation.
 12. Skip [Step #1](#) of install left front drain tube for vehicles equipped with a manual transmission only and proceed to [Step #1](#) right front sunroof drain tube.

INSTALL LEFT FRONT DRAIN TUBE FOR VEHICLES EQUIPPED WITH A MANUAL TRANSMISSION ONLY:

1. Remove the air cleaner body. Refer to the detailed removal procedures available in DealerConnect> TechCONNECT under: Service info> Engine> Air Intake System> Body, Air Cleaner> Removal.
2. Remove the master cylinder. Refer to the detailed removal procedures available in DealerConnect> TechCONNECT under: Service info> Brakes> Hydraulic/Mechanical> Master Cylinder, Brake> Removal.
3. Remove the lower left side cowl trim panel. Refer to the detailed removal procedures available in DealerConnect> TechCONNECT under: Service info> Body> Interior> Panel, Cowl Trim, Side> Removal.

4. Remove the clutch pedal for access to the bulk head where the drain tube will be routed.
5. Route the new left side sunroof drain tube through the engine side of the bulkhead (Fig. 5).

NOTE: From underneath the left side instrument panel roll back the jute between the bulk head and the instrument panel at the top left to verify drain tube routing.

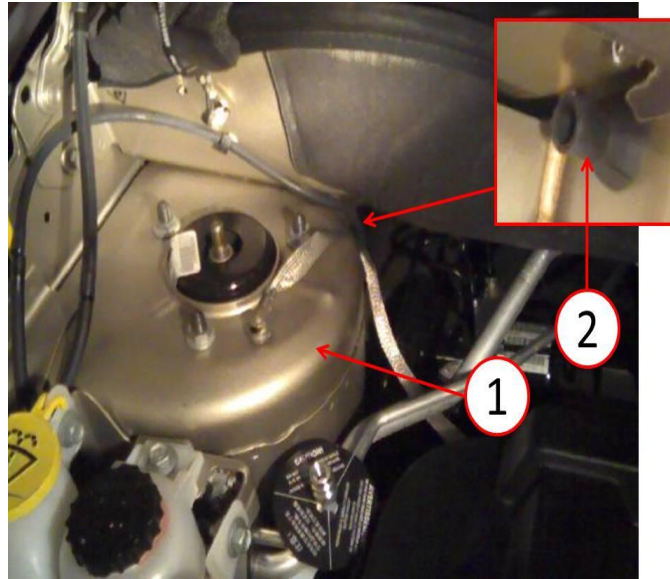

Fig. 5 Right Front Drain Tube

- 1 - Right Strut Tower
 - 2 - Drain Tube Grommet
-

6. Verify the grommet is correctly seated in the bulk head using a mirror and position it behind the strut tower looking at the upper right corner (Fig. 6).

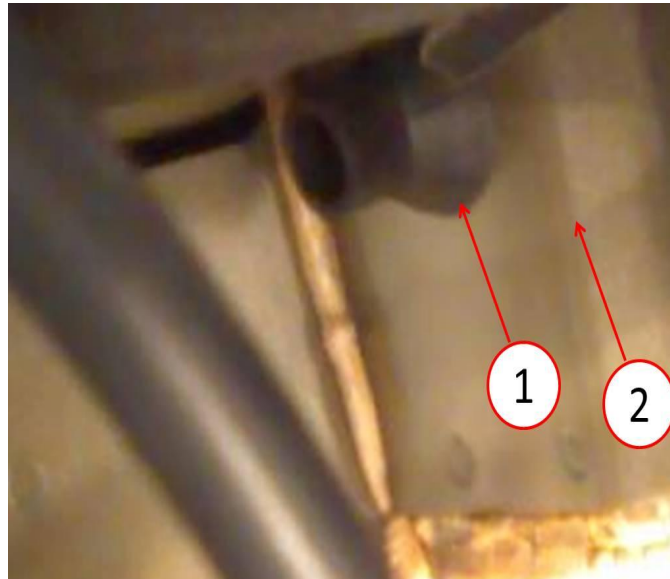

Fig. 6 Drain Tube Grommet Seated

- 1 - Drain Tube Grommet
- 2 - Bulk Head

-
7. Connect the drain tub to the sunroof drain spout.
 8. Install the clutch pedal.
 9. Install the lower left side cowl trim panel. Refer to the detailed installation procedures available in DealerConnect> TechCONNECT under: Service info> Body> Interior> Panel, Cowl Trim, Side> Installation.
 10. Re-install the master cylinder. Refer to the detailed Installation procedures available in DealerConnect> TechCONNECT under: Service info> Brakes> Hydraulic/Mechanical> Master Cylinder, Brake> Installation.
 11. Install the air cleaner body. Refer to the detailed Installation procedures available in DealerConnect> TechCONNECT under: Service info> Engine> Air Intake System> Body, Air Cleaner> Installation.

RIGHT FRONT SUNROOF DRAIN TUBE:

1. Install the right front sunroof drain tube.
2. Remove the lower right side cowl trim panel. Refer to the detailed removal procedures available in DealerConnect> TechCONNECT under: Service info> Body> Interior> Panel, Cowl Trim, Side.

3. Route the new right side sunroof drain tube through the engine side of the bulkhead (Fig. 7).

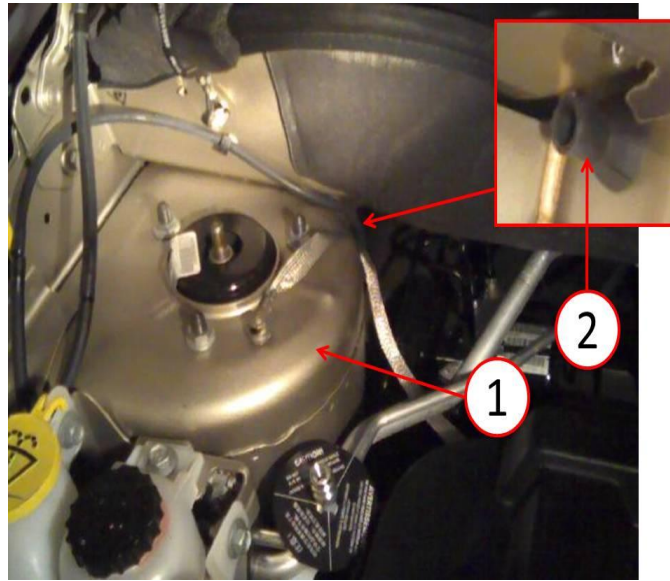

Fig. 7 Right Front Drain Tube

- 1 - Right Strut Tower
- 2 - Drain Tube Grommet

NOTE: From underneath the left side instrument panel roll back the jute between the bulk head and the instrument panel at the top left to verify drain tube routing.

4. Position a mirror behind the right strut tower and verify the grommet is properly seated against the bulkhead(Fig. 8).

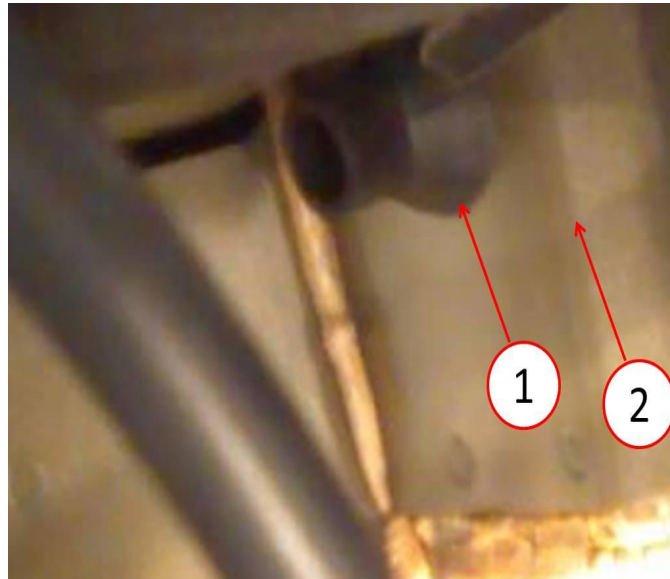

Fig. 8 Drain Tube Grommet Seated

- 1 - Drain Tube Grommet
- 2 - Bulk Head

-
5. Connect the drain tub to the sunroof drain spout.
 6. Install the lower right side cowl trim panel. Refer to the detailed installation procedures available in DealerConnect> TechCONNECT under: Service info> Body> Interior> Panel, Cowl Trim, Side> Installation.

REAR DRAIN TUBES:

1. Remove the right and left rear drain tubes. Refer to the detailed removal procedures available in DealerConnect> TechCONNECT under: Service info> Body> Sunroof> Tube, Sunroof Drain> Removal.
2. Install the new rear sunroof drain tubes. Refer to the detailed installation procedures available in DealerConnect> TechCONNECT under: Service info> Body> Sunroof> Tube, Sunroof Drain> installation.
3. Proceed to [Step #1](#) of the verification procedure.

ROOF SEAMS AND REAR BODY PLUGS:

1. Using a trim stick remove the right and left roof ditch moldings.
2. Remove all adhesive residue in the roof ditch with 3M General Purpose Adhesive Cleaner 08984 or Equivalent with a general purpose cloth.

3. Apply a clear paintable seam sealer such as Kent Hi-Tech Seam Sealer P10200 or equivalent along both sides of the roof ditch seam as shown in (Fig. 9).

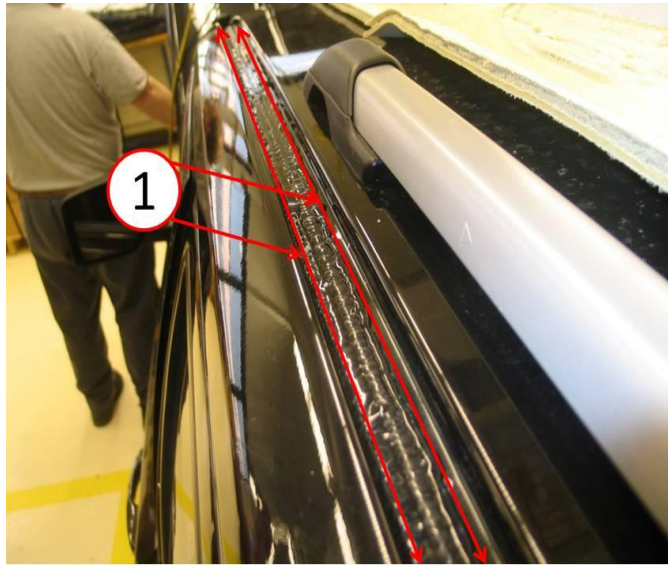

Fig. 9 Roof Ditch

1 - Clear Seam Sealer

4. At the rear check all body plugs and grommets (Fig. 10) and verify they are properly seated.

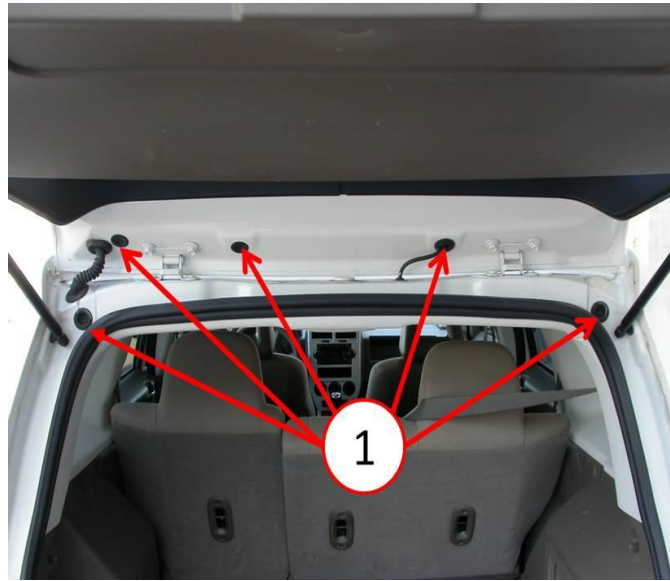

Fig. 10 Grommets And Plugs

1 - Grommets And Plugs

5. At the rear roof panel apply Kent Hi-Tech Seam Sealer P10200 or equivalent around the patch shown in (Fig. 11) on the right and left side.

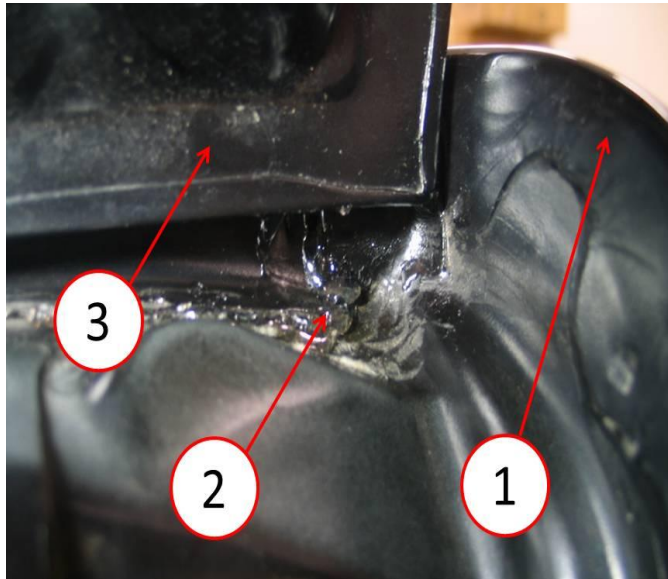

Fig. 11 Roof Seam

- 1 - Side Aperture
- 2 - Sealer
- 3 - Tailgate

-
6. Allow the sealer to fully cure per adhesive manufacturers recommendations.
 7. Install the right an/or left roof ditch molding(s).

NOTE: When installing the roof ditch molding apply firm pressure to the molding so proper wet is achieved to insure proper adhesion.

VERIFICATION PROCEDURE:

1. Perform a water flow test and verify there are no water leaks.
2. Return the vehicle to the customer.

POLICY:

Reimbursable within the provisions of the warranty.

TIME ALLOWANCE:

| Labor Operation No: | Description | Amount |
|----------------------------|--|---------------|
| 23-50-57-93 | Inspect and water test (C) | 0.3 Hrs. |
| 23-50-57-94 | Inspect and Water Test, Repair One Roof Seam (C) | 1.8 Hrs. |
| 23-50-57-95 | Inspect and Water Test, Repair Both Roof Seams (C) | 2.2 Hrs. |
| 23-30-63-96 | Inspect and Water Test, Replace Sunroof Drain Tubes With (Auto Trans) Only (C) | 2.4 Hrs. |
| 23-30-63-97 | Inspect and Water Test, Replace Sunroof Drain Tubes with (Manual Trans) Only (C) | 3.2 Hrs. |
| 23-30-63-98 | Inspect and Water Test, Replace Sunroof Drain Tubes ,Repair Both Roof Seams Only (C) | 3.3 Hrs. |

FAILURE CODE:

| | |
|----|----------------|
| ZZ | Service Action |
|----|----------------|